



5,6-30m



5,94x5,95m



3,2t



360°



75%

	5,6	9,2	12,6	16,1	19,6	23,1	26,6	30	
2,5	18,7	35	25	23	19	15,7			2,5
3	14,5	32	25	21,5	18,2	15,2	12,1	9,5	3
4		27	22	18,5	16,2	13,8	12,1	9,5	4
5		21	19,3	16	14,1	12,3	10,8	8,9	5
6		17	16,6	14	12,4	10,9	9,8	8,1	6
7			13,3	12,4	11	9,9	8,9	7,5	7
8			10,1	10,4	9,9	8,9	8	6,9	8
9			8,1	8,2	8,6	8	7,4	6,5	9
10				6,7	7	7,3	6,8	6	10
12				5,3	5,1	5,2	5,5	5,1	12
14					4,1	4,4	4,1	4,4	14
16					3,2	3,5	3,6	3,4	16
18						2,7	3	2,6	18
20						2,1	2,4	2,1	20
22							2	1,6	22
24							1	1,3	24
26								1	26



5,6-30m



5,94x4,13m



3,2t





360°



DIN



75%

	5,6	9,2	12,6	16,1	19,6	23,1	26,6	30	
2,5	18,7	32,8	25	23	19	15,7			2,5
3	14,5	29,2	25	21,5	18,2	15,2	12,1	9,5	3
4		22	21,4	18,5	16,2	13,8	12,1	9,5	4
5		15	14,1	14,4	14,1	12,3	10,8	8,9	5
6		10,5	10,8	10,6	10,5	10,9	9,8	8,1	6
7			8,1	8,4	8,6	8,3	8,6	7,5	7
8			6,3	6,4	7	7,3	6,9	6,9	8
9			5	5,4	5,7	6	6,1	5,9	9
10				4,4	4,7	5	5,3	4,9	10
12				3	3,3	3,6	3,9	3,5	12
14					2,4	2,6	2,9	2,6	14
16					1,7	2	2,2	1,9	16
18						1,5	1,7	1,4	18
20						1,1	1,3	1	20
22							1	0,7	22
24								0,4	24

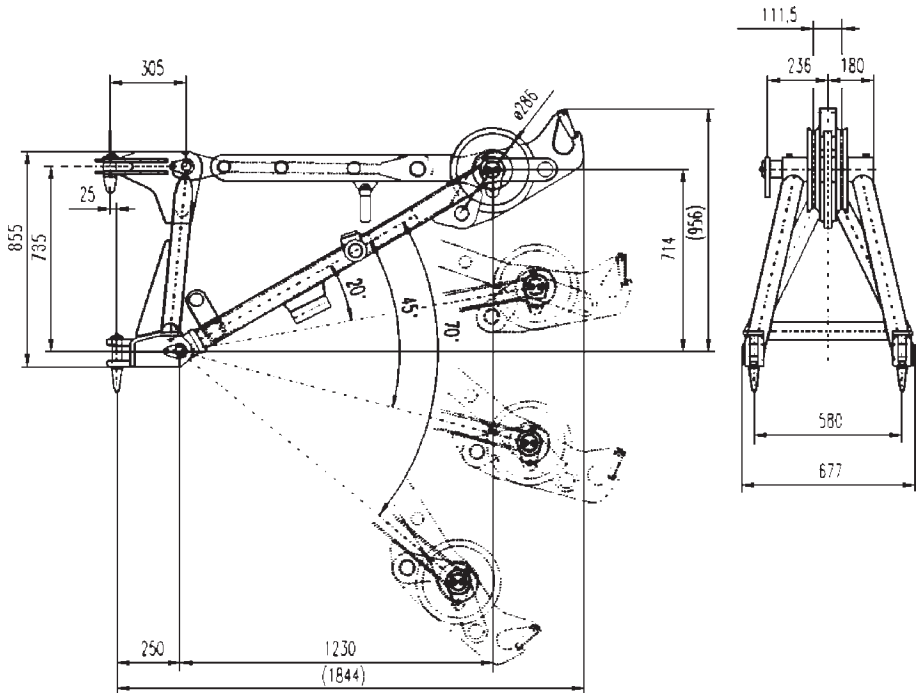

1,2 m Montagespitze







	5,6				9,2				12,6				
	0°	20°	45°	70°	0°	20°	45°	70°	0°	20°	45°	70°	
1			10,1	8,5			10,8	8,9					1
1,5		11,6	9,8	8,4			10,6	8,8					1,5
2		11,6	9,4	8,2			10,3	8,6					2
2,5		11,1	9,1	8,1			10	8,4			10,5	8,6	2,5
3	11,6	10,6	8,8	8			9,8	8,3			10,2	8,5	3
4	11,4	9,7	8,4			11,6	9,3	8,1			9,8	8,3	4
5						10,9	8,9	8		11,6	9,4	8,1	5
6					11,6	10,2	8,5	8		11,4	9,1	8	6
7					11,6	9,7	8,4			10,8	8,8	7,9	7
8						9,3	8,4		10,2	10,3	8,5	7,9	8
9									8	8,2	8,3	7,9	9
10									6,4	6,6	6,7	6,8	10

Montagespitze im Seilrollenbetrieb



	16,1				19,6				
	0°	20°	45°	70°	0°	20°	45°	70°	
2,5			10,6	8,7			10,3	8,6	2,5
3			10,4	8,6			10,2	8,6	3
4			10,1	8,4			9,9	8,4	4
5			9,7	8,2			9,7	8,3	5
6			9,4	8,1			9,5	8,1	6
7		11,6	9,1	8			9,3	8	7
8		10,6	8,9	7,9		9,9	9	7,9	8
9		8,4	8,6	7,9		8,7	8,8	7,9	9
10		6,7	6,9	7		7	7,2	7,3	10
12	4,4	4,6	4,7			4,8	5	5	12
14	3,1	3,2	3,3		3,3	3,4	3,5	3,6	14
16					2,4	2,4	2,5		16
18							1,8		18

Montagespitze im Seilrollenbetrieb



	5,6				9,2				12,6					
	0°	20°	45°	70°	0°	20°	45°	70°	0°	20°	45°	70°		
1				6,3				6,4					1	
1,5				6,2				6,3					1,5	
2				6,1				6,2				6,3	2	
2,5			6,4	6,1				6,2				6,2	2,5	
3		7,2	6,3	6			6,4	6,1				6,1	3	
4	7,7	6,8	6,1				6,3	6				6,1	4	
5						7,2	6,2	6			6,3	6	5	
6						7	6,1	6			6,2	6	6	
7					7,9	6,8	6,1				6,1	5,9	7	
8						6,5	6				6,9	6	5,9	8
9											6,8	6	5,9	9
10									6	6,2	6	5,9	10	

Montagespitze im Hakenbetrieb



	16,1				19,6				
	0°	20°	45°	70°	0°	20°	45°	70°	
2,5				6,1				5,8	2,5
3				6				5,8	3
4				5,9				5,7	4
5				5,9				5,7	5
6			6,1	5,8				5,6	6
7			6	5,8				5,6	7
8			5,9	5,8			5,8	5,6	8
9			5,9	5,8			5,7	5,6	9
10		5,9	5,8	5,8			5,4	5,5	10
12		4,7	4,8			4,8	4,8	4,9	12
14	3,2	3,3	3,3			3,5	3,6	3,6	14
16					2,4	2,5	2,6		16

Montagespitze im Hakenbetrieb

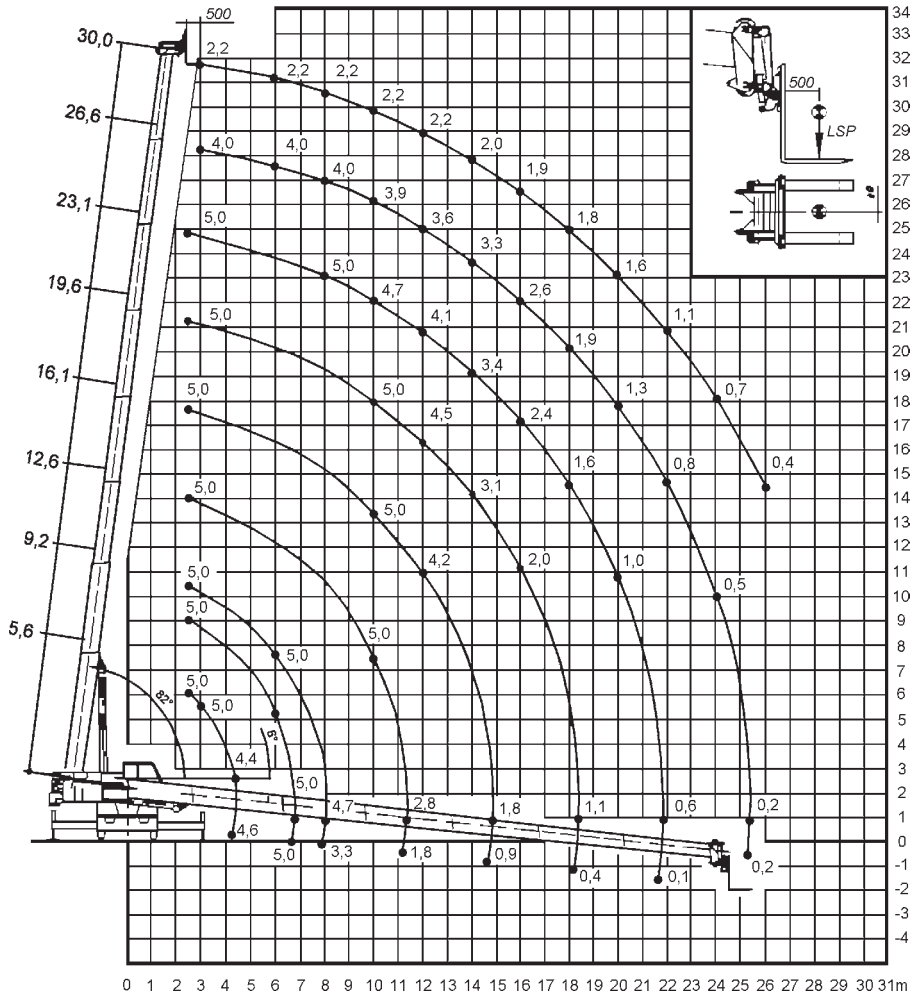
Die Arbeitsbereiche





 5,6-30m	Mit Gabelzinken und Schwerlastadapter	 5,94x5,95m	 3,2t	 360°	 75%
--	---------------------------------------	---	---	---	---

	5,6	9,2	12,6	16,1	19,6	23,1	26,6	30	
2,5	5	5	5	5	5	5			2,5
3	5	5	5	5	5	5	4	2,2	3
4		5	5	5	5	5	4	2,2	4
5		5	5	5	5	5	4	2,2	5
6		5	5	5	5	5	4	2,2	6
7			5	5	5	5	4	2,2	7
8			5	5	5	5	4	2,2	8
9			5	5	5	5	4	2,2	9
10			5	5	5	4,7	3,9	2,2	10
12				4,2	4,5	4,1	3,6	2,2	12
14					3,1	3,4	3,3	2	14
16					2	2,4	2,6	1,9	16
18						1,6	1,9	1,8	18
20						1	1,3	1,6	20
22							0,8	1,1	22
24							0,5	0,7	24
26								0,4	26

Gabelzinken 900 mm Länge, LSP 500 mm

 5,6-30m	Mit Gabelzinken und Schwerlastadapter	 5,94x5,95m	 3,2t	 360°	 75%
--	---------------------------------------	---	---	---	---

	5,6	8,9	12,4	16	
2,5	5	4	4	4	2,5
3	5	4	4	4	3
4		4	4	4	4
5		3,6	3,4	3,3	5
6		2,7	2,6	2,6	6
7			2	2	7
8			1,4	1,4	8
9			1	1	9
10				0,7	10
12				0,2	12

Tragfähigkeiten in t bei 500 mm Lastschwerpunkt

